

产品名称：吸收式压控衰减器

产品型号：HD-812VA30S

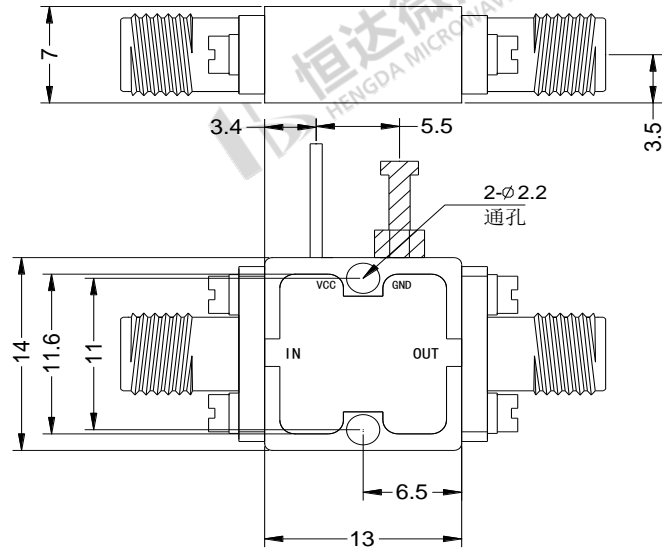

1. 详细技术参数 (*为主要参数)

参 数	最小值	典型值	最大值	单位
频率范围		8-12		GHz
衰减范围	30			dB
插入损耗		1.7	2.0	dB
插损随温度变化值		0.003		dB/ ° C
输入驻波比		1.5	1.8	: 1
输出驻波比		1.5	1.8	: 1
0.1dB压缩点			27	dBm
输入IP3值		45		dBm
切换速度		2.5		us
控制电压范围	0	10		V
重量		9.92		g
阻抗		50		Ω
电流		15		mA
输入输出连接头	SMA - Female			
表面处理	镀金			
腔体材料	铝			
封装形式	标准封装 (气密封装可选)			

2. 额定参数与环境

控制电压	DC-13V
射频输入功率	+30dBm
工作温度	-45°C~+85°C
存储温度	-55°C~+125°C
海拔高度	762米 (环氧树脂密封条件)
	1524米. 最小1个标准大气压(气密封装条件)(可选)

3. 产品测试图

插入损耗 (+25°C)

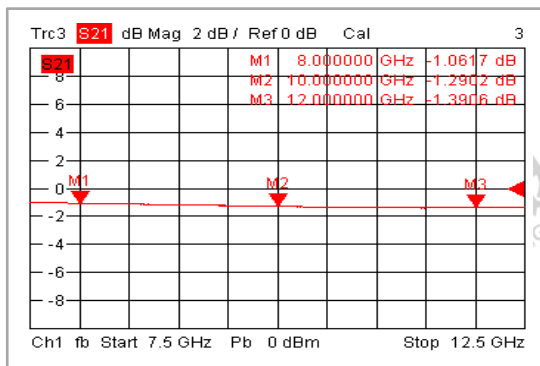

输入驻波比 (+25°C)

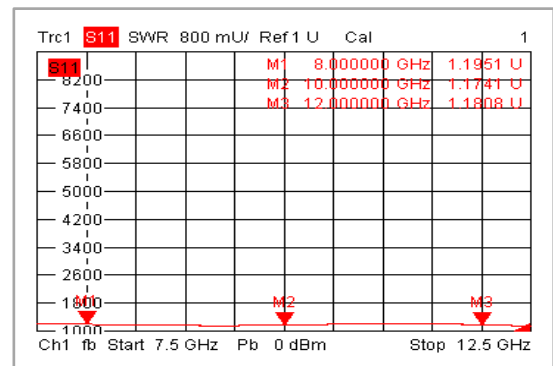

输出驻波比 (+25°C)

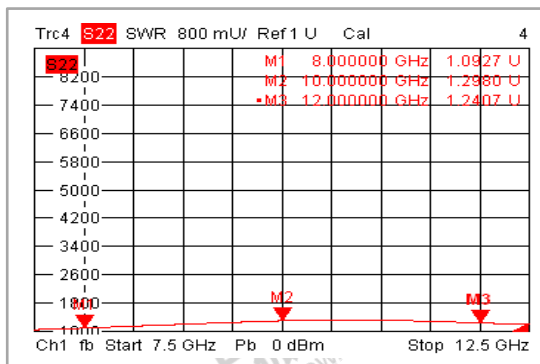

插入损耗 (-45°C)

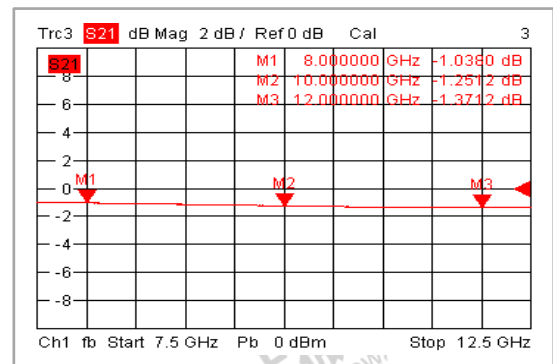

输入驻波比 (-45°C)

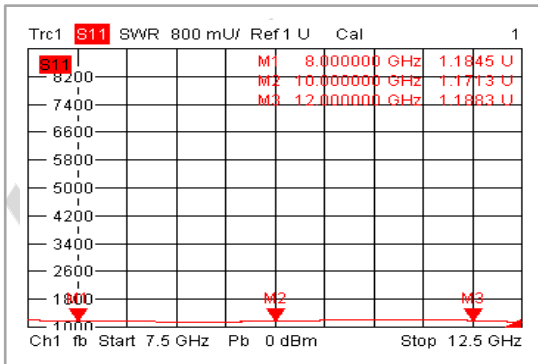

输出驻波比 (-45°C)

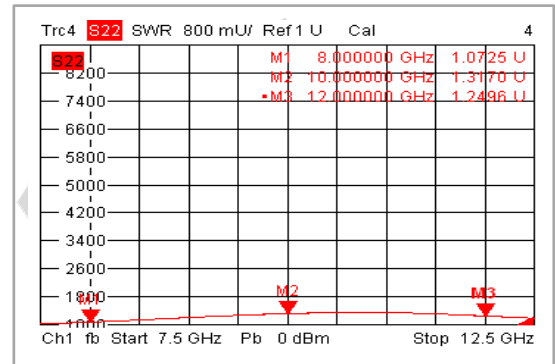

插入损耗 (+85°C)

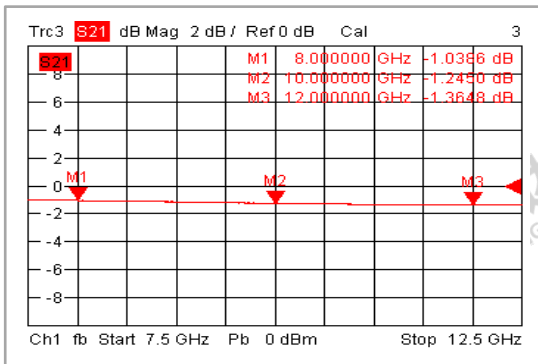

输入驻波比 (+85°C)

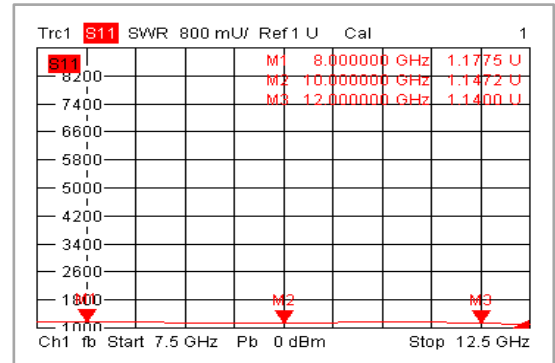

输出驻波比 (+85°C)

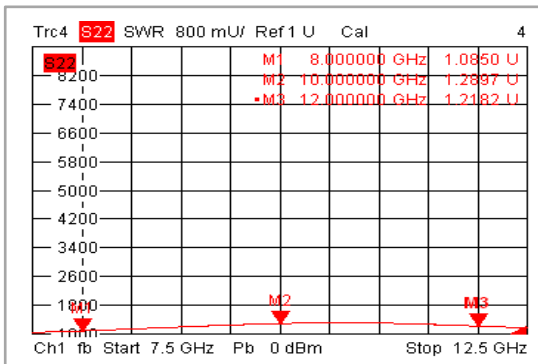

衰减/频率

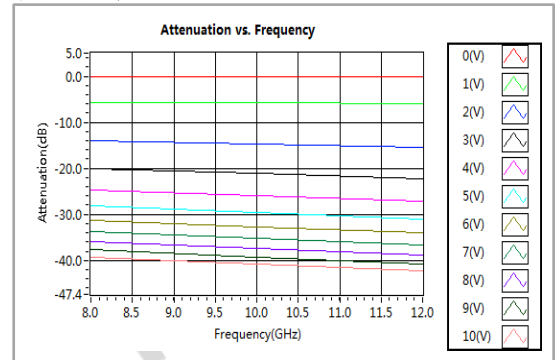

输入驻波比/电压

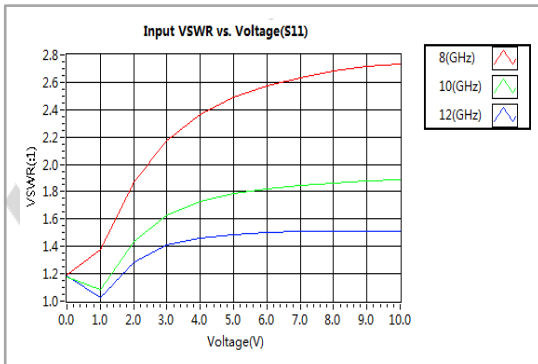

输出驻波比/电压

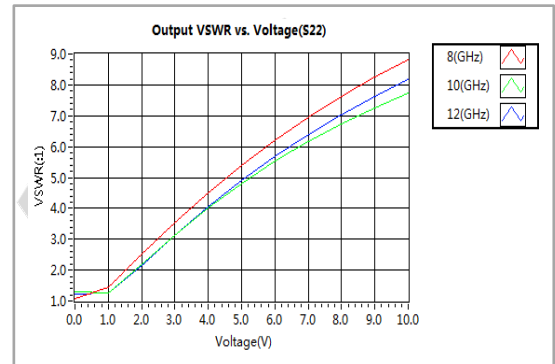

移相相位/频率

