

产品名称：反射式压控衰减器

产品型号：HD-12VA50S

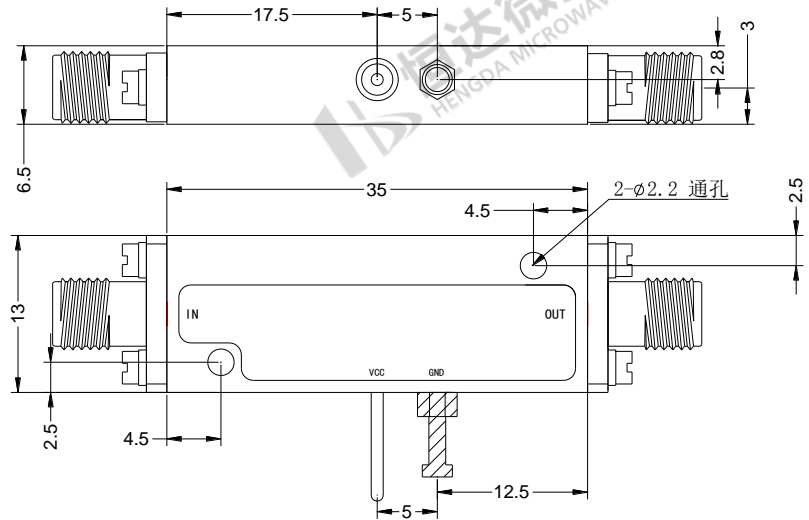

1. 详细技术参数 (*为主要参数)

参 数	最小值	典型值	最大值	单位
频率范围		1-2		GHz
衰减范围	50			dB
插入损耗		0.7	0.8	dB
插损随温度变化值		0.003		dB/ ° C
输入驻波比		1.2	1.4	: 1
输出驻波比		1.2	1.4	: 1
0.1dB压缩点			30	dBm
输入IP3值		45		dBm
切换时间		10		us
控制电压范围		DC-10		V
重量		9.92		g
阻抗		50		Ω
电流		40		mA
输入输出连接头	SMA-Female			
表面处理	镀金			
腔体材料	铝			
封装形式	标准封装 (气密封装可选)			

2. 额定参数与环境

控制电压	0-13V
射频输入功率	+32dBm
工作温度	-45°C~+85°C
存储温度	-55°C~+125°C
海拔高度	762米 (环氧树脂密封条件)
	1524米. 最小1个标准大气压(气密封装条件)(可选)

3. 产品测试图

插入损耗 (+25°C)

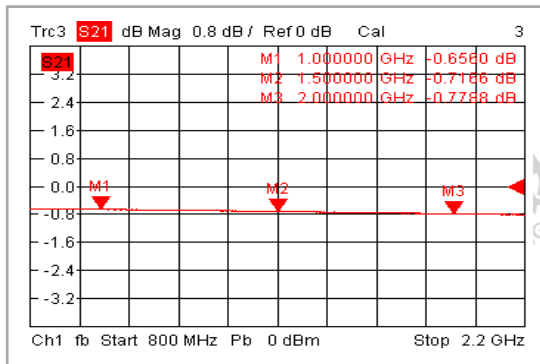

输入驻波比 (+25°C)

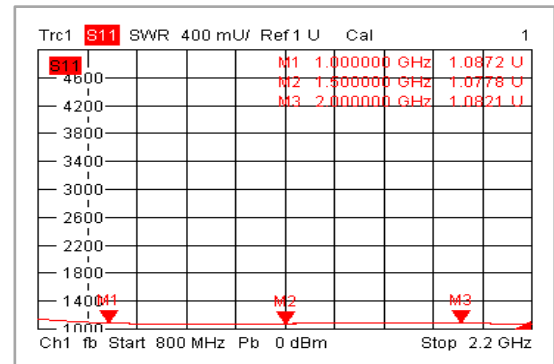

输出驻波比 (+25°C)

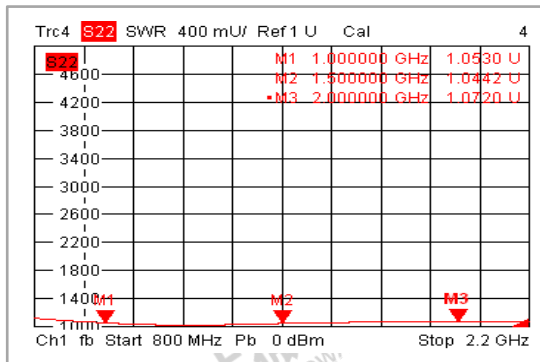

插入损耗 (-45°C)

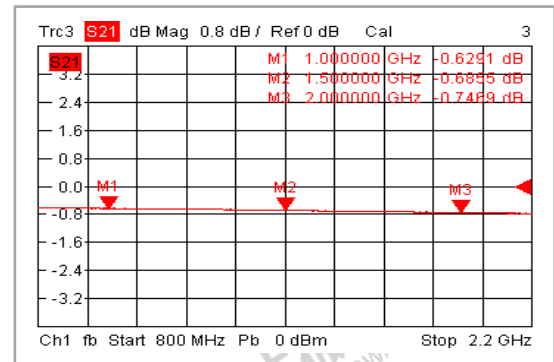

输入驻波比 (-45℃)

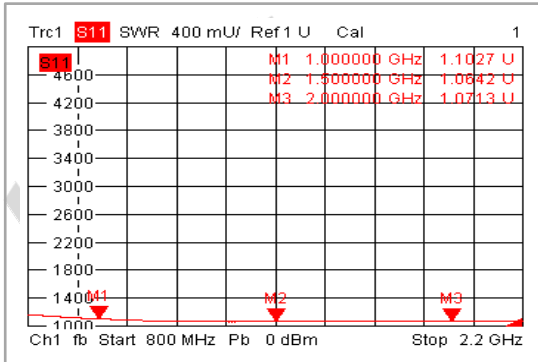

输出驻波比 (-45℃)

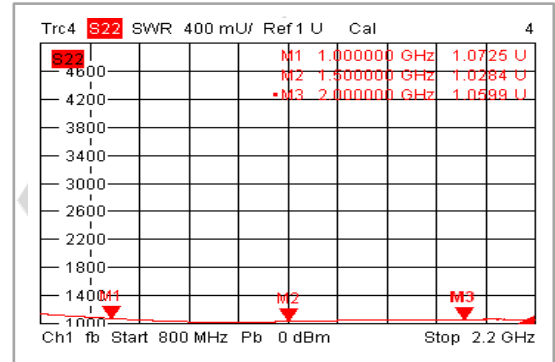

插入损耗 (+85℃)

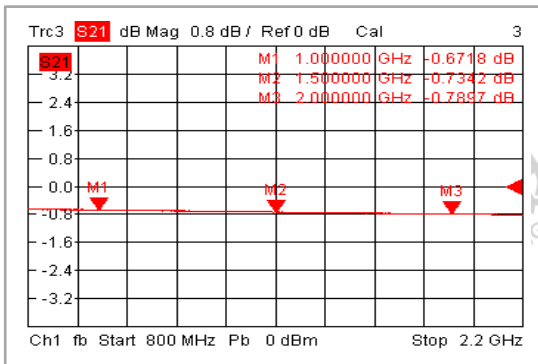

输入驻波比 (+85℃)

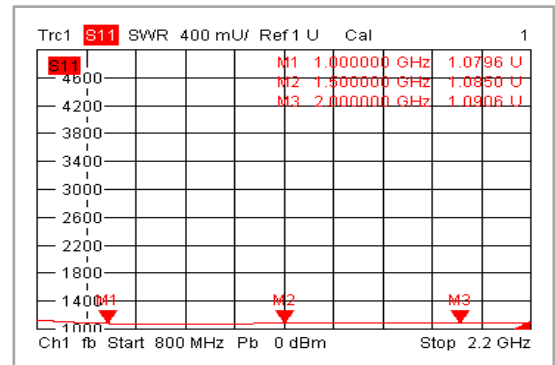

输出驻波比 (+85℃)

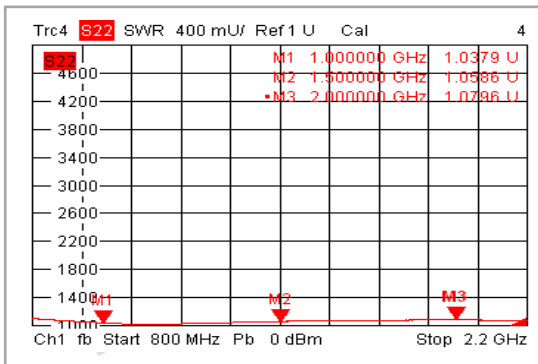

衰减/频率

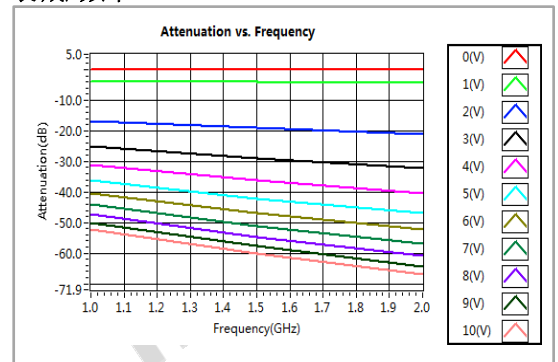

输入驻波比/电压

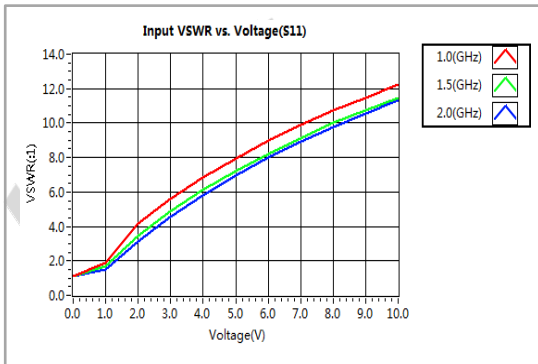

输出驻波比/电压

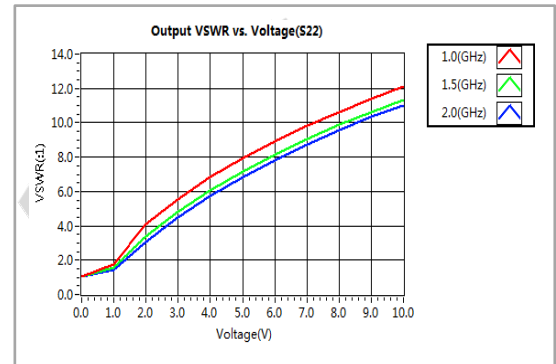

移相相位/频率

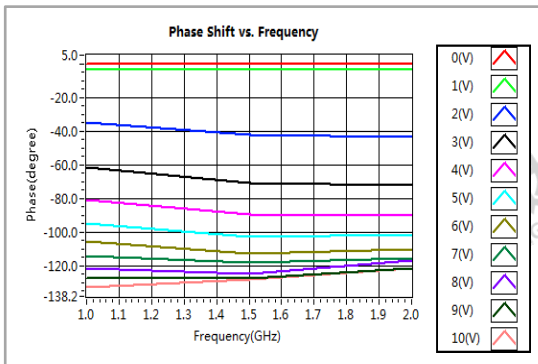

时间

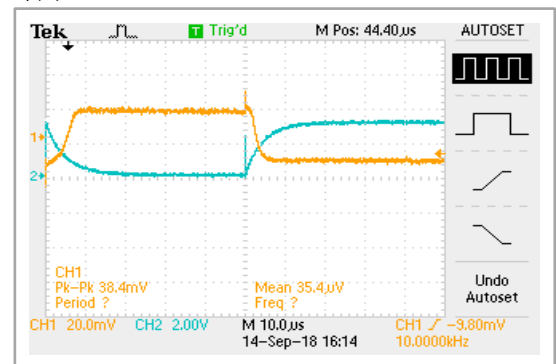

时间

